

YBA

Owner's Manual

Genesis S2 Streaming Music Centre



INDEX

| | |
|-------------|---|
| Pages 3-5 | Precautions and warranty information |
| Page 6 | Discovering S2: Front view |
| Pages 7-8 | Discovering S2: Rear view |
| Page 9 | Copying music files to the build-in SSD drive |
| Page 10 | Remote handset operation |
| Pages 11-18 | Operation |
| Page 19 | S2 Specifications |

Warnings and Precautions



CAUTION: To reduce the risk of electric shock, do not try to open the device. No user serviceable parts inside. Refer servicing to qualified service personnel only.



The lightning flash with an arrowhead symbol within an equilateral triangle is intended to alert the user to the presence of un-insulated dangerous voltage within the product's enclosure which may be of sufficient magnitude to constitute a risk of electric shock.



The exclamation point within an equilateral triangle is intended to alert the user to the presence of important operating and maintenance (servicing) instructions in the literature accompanying the product.

This product is designed and manufactured to meet strict quality and safety standards. You should read all the safety and operating instructions before using the product. Retain the manual for future reference and adhere to all warnings in the manual or on the amplifier.

WARNING: To reduce the risk of fire or electric shock, do not expose this product to rain or moisture.

The presence of electricity near water can be dangerous. Do not use this product outdoors or near any source of water for example next to a bathtub, washbowl, kitchen sink, in a wet basement or near a swimming pool, etc. Take care that objects do not fall and liquids are not spilled into the enclosure through any openings.

Do not place this product on a bed, sofa, rug or similar soft surface, or in an enclosed bookcase or cabinet, where ventilation may be impeded. We recommend a minimum distance of 100 mm (4 inches) around all sides and top of the product to provide adequate ventilation. Be sure that the ventilation holes below and on the top cover of your product are neither covered nor obscured by any object or dust.

Locate the product away from naked flames or heat producing equipment such as radiators, stoves or other appliances (including other electronic devices) that produce heat. The amplifier has been designed for use in moderate climates.

You should never attempt to service the product beyond that described in this manual. All other servicing should be referred to qualified service personnel. The only fuse used in this device is on the AC socket. Always use exactly the same fuse as the one provided with your unit.

If an abnormal smell or smoke is detected from the product, turn the power off at once and unplug the unit from the wall outlet. Contact your dealer immediately.

The product should be referred to qualified service personnel when:

The power supply cord or plug is damaged

The product has been dropped or the enclosure has been damaged

Objects have fallen, or liquid has been spilled, into the product

The product has been exposed to moisture

The product does not appear to function normally or exhibits a marked change in performance

We thank you for your purchase of our YBA Genesis product. We are confident that it will provide you with many years of listening pleasure.

YBA Genesis products have been manufactured with the same pride and attention to detail as every other product made since our creation in 1981. Your new product will give you the very best audio quality.

This user manual has been designed to give you all the information you need to install, connect, setup and use your product. For your own safety and to ensure that no damage occurs, we strongly recommend that you read the safety guidelines carefully before installation.

It is our recommendation that you use a rack or stand that is recommended for use with audio equipment. If your equipment is on a portable rack it should be moved with great care, to avoid any accident.

It is always advisable to unplug the unit from the mains supply before cleaning. The casework should normally only require a wipe with a soft, damp, lint-free cloth. Do not use paint thinners or other chemical solvents for cleaning or furniture cleaning sprays or polishes as they can cause indelible white marks.

Only connect the product to a power supply of the type described in the operating instructions or as marked on the rear panel. Be sure to check the noted voltage. Power supply cords should be routed so that they are not likely to be walked on or pinched by items placed upon or against them. Only use the power supply cord supplied with your amplifier.

Unplug the power cord or switch it off if left unused for a long period of time.

This product has been designed to meet the IEC 62368 international electrical safety standard as well as CE and RoHs regulations. The pictorial "crossed-bin" means the equipment must not be thrown with ordinary wastes but must be collected for reuse, recycling and other forms of recovery. If no longer required it must therefore be deposited in an appropriate collection point.

YBA is a registered trademark of YBA SAS and is restricted for use by YBA, its subsidiaries and authorized agents. All other brands and product names quoted in this manual are registered trademarks and the property of their respective owners.

Disclaimer: All the information contained in this manual was correct at the time of publication. However, as our engineers are always updating and striving to improve our products, your product may have slightly different appearance, performance, or modified functionality than presented in this manual.

YBA Warranty Policy Information

YBA warrants this product to be free from defects in materials and workmanship subject to the following:

The warranty period may vary from country to country and according to local regulations. Consult your dealer or distributor to confirm the warranty duration in your country.

YBA will repair or replace this product (at YBA's sole option) or any defective parts in this product within the terms of the warranty.

YBA warranty applies to the original purchaser only. **Always** ensure that you retain a valid proof of purchase.

YBA shall not be liable for any incidental or consequential damages for breach of any express or implied warranty in this product.

Except to the extent prohibited by law, this warranty is exclusive and in lieu of all other express and implied warranties.

YBA warranty does not affect your statutory rights.

Warranty Procedure

To obtain warranty service, please contact the YBA authorized dealer from whom you purchased this product. Your dealer will deliver the product to the registered YBA service centre.

Shipping to the service centre is at your cost and your amplifier must be packed in either its original carton or packaging affording an equal degree of protection.

Proof of purchase in the form of a bill of sale or receipted invoice, which is evidence that this product is within the warranty period, must be presented to obtain warranty service.

This warranty is invalid if

- (a) the factory-applied serial number has been modified, altered or removed from this product
- (b) this product was not purchased from a YBA authorized dealer
- (c) the product shows any evidence of repair or attempt to repair not performed by a YBA authorized service centre.

Warranty Exclusions

Maintenance and service or replacement of parts due to normal wear and tear

Problems arising from the misuse of the product or use of this product for non-domestic use

Damage to the outer chassis due to normal or abnormal wear and tear

Faults caused by extreme situations (such as damage due to lightning, floods, moisture, fire...)

Faults caused as a result of a short-circuit on the loudspeaker outputs

Faults caused by shock or the result of the product being dropped

Damage or defects caused by the use of inadequate packing during return to an authorized service centre

Faults caused by other devices or accessories such as power cords, power filters, loudspeakers

Damages due to repairs, modifications or cleaning by non-approved technicians or due to the use of non-YBA parts

Faults due to unauthorised opening or tampering with the unit

Any complete or partial loss of data/files

Discovering your S2: Front view

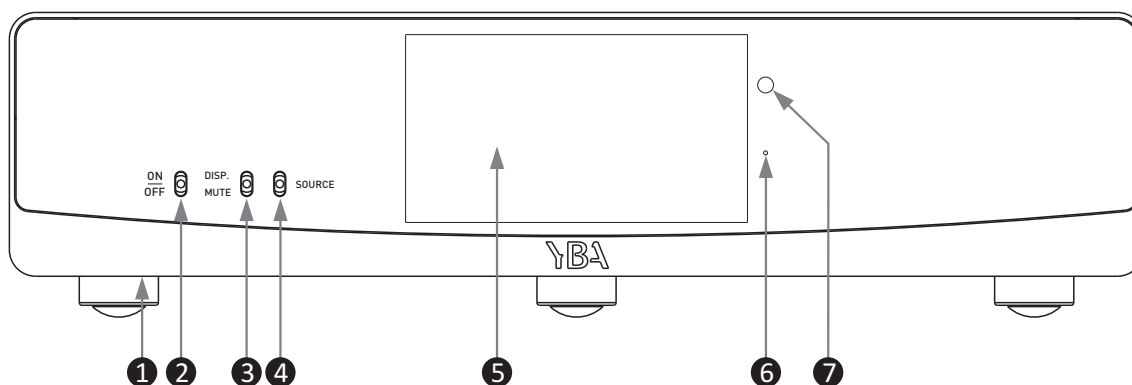

- ① Power Switch Use this switch underneath the machine to power on or power off the S2
- ② On/Off Toggle up to turn on from Standby / Toggle down to put in Standby
- ③ Disp/Mute Toggle to enable or disable the on-screen display / Switch down to mute the sound
- ④ Source Selects between the different inputs
- ⑤ Touchscreen 130 x 71 mm TFT LCD display (visible area)
- ⑥ Start up indicator When powered on the blue LED flashes. Solid blue machine is ready for use. If in standby LED is red
- ⑦ IR Sensor Point remote towards this sensor for control from a distance

Discovering your S2: Rear view

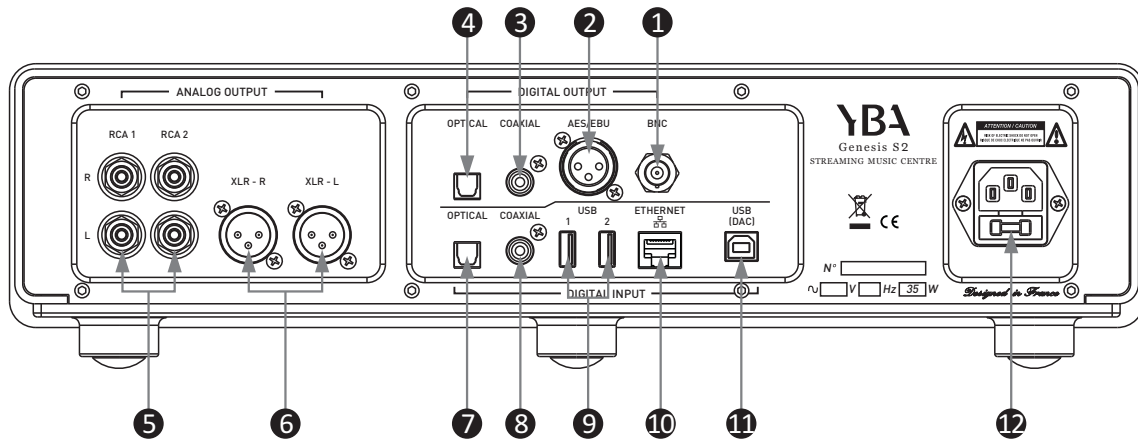

CAUTION

Before connecting or disconnecting any input or output always make sure your S2 is in the OFF position. If you have any doubt, unplug the AC cable from the power inlet.

Make sure all components connected to your player are all set to off.

Neatly arrange and organize wiring to and from your S2 and to and from all your components. Separate AC wires from audio cables to prevent hum or other unwanted noise from being introduced into the system.

- | | |
|--------------------------|---|
| ① BNC digital output | The BNC digital output allows you to connect an external DAC or a digital recorder. |
| ② AES/EBU digital output | The AES/EBU digital output allows you to connect an external DAC or a digital recorder. |
| ③ Coaxial digital output | The coaxial digital output allows you to connect an external DAC or a digital recorder. |
| ④ Optical digital output | The optical digital output allows you to connect an external DAC or a digital recorder. |
| ⑤ RCA outputs 1 and 2 | Pre-amplified output. If you want to use a subwoofer, a separate power amplifier or some active speakers, use this connection |

Discovering your S2: Rear view

- 6** XLR output

Balanced outputs must be used with equipment with balanced inputs. YBA believes that RCA connections are of better quality than XLR connections, unless the cable connection is very long.

XLR connectors should be wired: Pin 1 - Ground; Pin 2 - Hot (in-phase); Pin 3 - Cold (phase-inverted).
- 7** Optical digital input

Connect to optical output from a digital audio source (for example a digital television) by optical cable.
- 8** Coaxial input

Connect to coaxial output from a digital audio source by coaxial cable.
- 9** USB 1 and USB 2

USB (type A) host port, for USB stick drive or USB hard disk drive use.
- 10** Ethernet input

Connect the unit to the network permanently with RJ45-RJ45 straight through (not crossover) networking cable. Use cable suited to the network type, e.g. 10/100 base-T (most home networks). This allows the unit to be plugged into a computer network, and is strongly recommended where a wired connection is already available or can be installed. Standard UTP RJ45 networking cable should be used to connect the unit to the networking router. This is an option to choosing to use a wireless connection.
- 11** USB-DAC

The USB Type B input allows a direct connection to a PC/Mac; The S2 operation is fully independent of your computer built-in soundcard and will operate whether your computer has a soundcard or not.
- 12** Power inlet

Use the mains cable provided with your S2. Be sure the switch is in the OFF position before plugging or unplugging the mains cable.

Copying music files to the build-in SSD drive

S2 comes with a build-in 1TB NVME SSD drive for storing music files.

If you wish to copy your music library onto the drive, it's recommended to remove the drive from the S2 and connect it directly to your computer to copy in all the files.

SSD Drive is connected to a USB adapter and can be connected directly to USB ports on your computer.

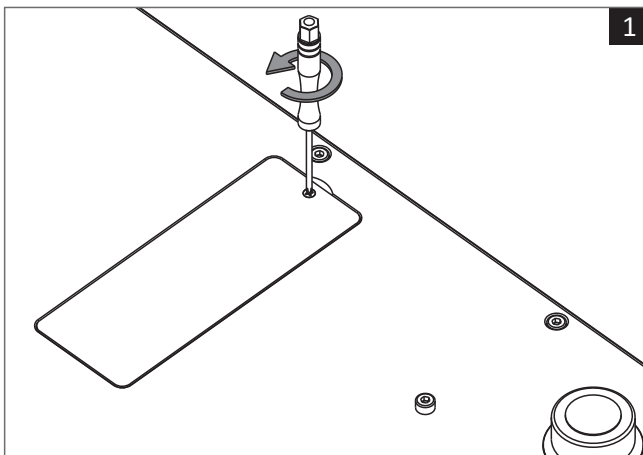

Use screwdriver to remove the screw on the bottom of S2.

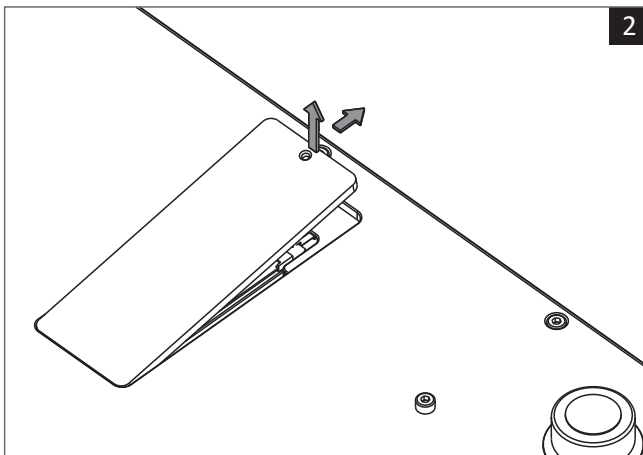

Remove the disk cover.

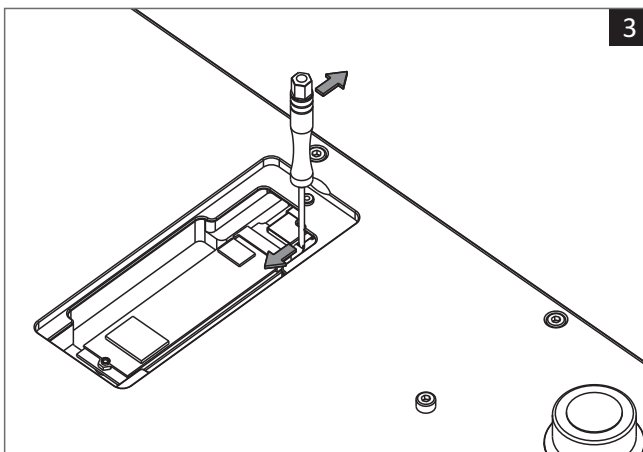

Use screwdriver or other tool to push on the drive, pushing it out from the inner USB slot.

REMOTE HANDSET OPERATION

Note: **PRESS** means a short press on a key while **HOLD** means to keep the key pressed for more than 3 seconds.

Always point the remote towards the IR window of your S2

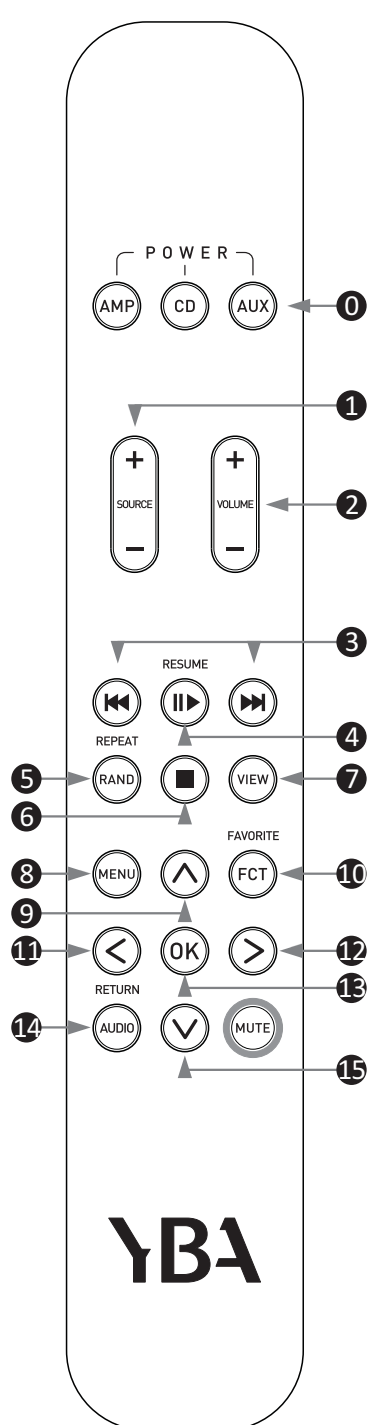

- 0 **Select** the device you want to control. To control the S2 select AUX
- 1 **SOURCE+/SOURCE-**: Press SOURCE+/SOURCE- to skip to the desired source.
- 2 **Volume + / -**: Press to control volume of S2, acting as a pre-amplifier for power amplifier or active speakers.
- 3 **Previous/Next Track (▶▶ / ◀◀)**: Press ◀◀ to return to start of track or ▶▶ to play the next track. Hold > 3 seconds for fast forward or fast back to beginning or end of song.
- 4 **Play/Pause**: Press to toggle between play (▶) and pause (⏸)
- 5 **Random (RAND)**: Press to toggle between shuffle and list play. Choose OK. Hold to repeat current track
- 6 **Stop (■)**: Press to stop playback
- 7 **View**: By pressing the View button for more than three seconds the display turns off. Press again and it turns on.
- 8 **Menu**: Press to return to selection menu (Local songs/network service etc.)
- 9 **Λ**: Press once goes to return arrow. Press OK returns to menu (Songs/Artist/Album etc.) Press again to go to selection menu (Local Songs/Network services etc.)
- 10 **FCT**: Press to add the currently playing track to the favourites menu.
- 11 **<**: Press once goes to return arrow. Press OK returns to menu (Songs/Artist/Album etc.) Use down, right and left arrows to navigate through menu to choose selection
- 12 **>**: Press once goes to return arrow. Press OK returns to menu (Songs/Artist/Album etc.) Using down, right and left arrows to navigate through menu to choose selection
- 13 **OK**: Confirms/selects item
- 14 **Return**: Press to return to menu. Navigate using arrow keys to select from Songs/Artists etc.
- 15 **v**: Press once goes to return arrow. Press OK returns to menu (Songs/Artist/Album etc.) Use down, right and left arrows to navigate through menu to choose selection.

OPERATION

Switching on/off

Press the switch under the front panel on the left hand side. A red indicator will appear on the right hand side of the touchscreen.

Toggle the front panel on/off switch upwards to on. Hold for 2-3 seconds. The red light will be replaced by a blue flashing light which will then become solid when the unit is ready for use. It is ready for use when you see the options screen.

To switch off at any time simply use the toggle switch in a downward motion to off and hold for 2-3 seconds. The unit will go into Standby, (red indicator). To turn off completely after this step, use the switch under the front panel.

Select Settings from the option screen

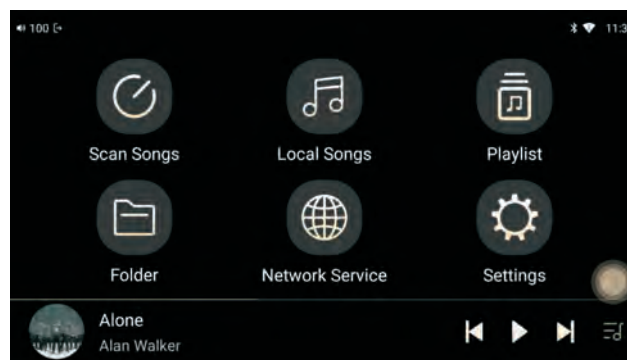

Firmware Update:

When a firmware update is available you will be advised. It is a simple process to follow. However because it is somewhat time consuming to update in this way, when updates are available a link will be posted on the YBA website. What we suggest you do is to open that link, download the ZIP file to a USB drive (do not unzip the file) and install the update directly from your USB. To do this you use either the USB1 or USB2 input and select firmware update/local upgrade and follow the prompts. Choose native update.

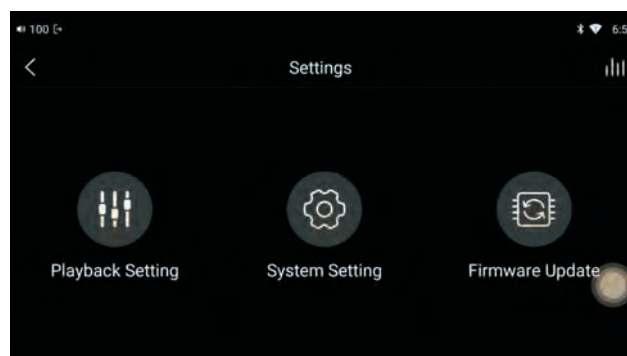

System Settings

When navigating through these settings, in order to return to the options swipe from left to right across the screen.

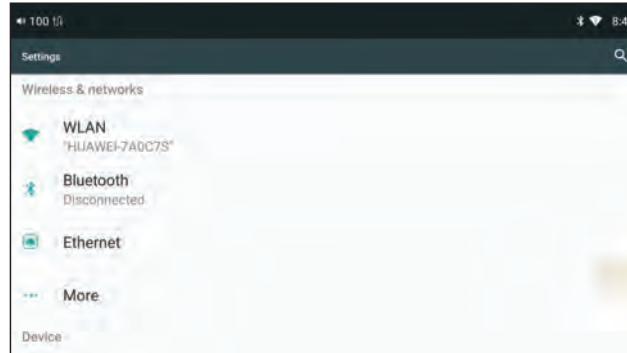

WLAN:

Available networks will be listed. Select and then enter details of your network. Be sure that you have selected the On button on the top right hand side.

Above the On indicator is a settings button. You have further options here if required.

Bluetooth:

To pair a device with the S2, open settings on the device (mobile/tablet etc.) Choose Bluetooth on the device and S2 will appear as an option. Select connect having made sure that on the S2 you have switched Bluetooth 'On'. Your device will then appear in the Bluetooth settings on the S2. Tap to select both and a code will appear on your device.

Tap this code to enable pairing. Remember your device can only have one pairing active at any one time.

When you stop using Bluetooth the connection will switch off.

Ethernet:

If you choose to use a wired internet connection, enter details here.

More:

This provides an opportunity to reset network settings

Virtual key model defaults to floating box mode - touching this circle on the screen acts as a return to previous screen.

Audio:

Fixed output sampling rate: Choose "Bypass" to play audio in its original unaltered form. Or choose from 48kHz all the way to DSD256 to set resampling or PCM to DSD conversion for all played audio files.

Select output: Pick between Pre-amplifier or Line-Out output, this will affect ability to control volume directly on the S2. Also available in swipe down menu.

Lowpass filter mode: Pick from six digital filters, affecting data processing in the DAC, affecting the overall sound.

Balance: Adjust channel balance.

Wireless Playback quality: Set which codec will be used when using S2 as Bluetooth transmitter. This setting has no effect on using S2 in Bluetooth receiver mode.

Airplay: Switch S2 into Airplay receiver. Also available in swipe down menu.

Storage:

Accessing internal storage of Android system and the internal SSD.

Next more personal preferences can be set

Languages:

Default is English. When using a keyboard screen other options will be available.



Backup and reset:

This will reset your S2 to the original factory settings and is best left untouched unless necessary.

Date and Time:

First scroll down through the options to select your time zone. Choose whether you prefer 12 or 24 hour format. Once done then scroll back up and select Automatic date and time and Automatic time zone.

Touch floating box to return to previous screens.

Playback Settings:

From this point on you will notice a back arrow at the top left of the screen for all future navigation. These settings are to be configured to your personal preferences.

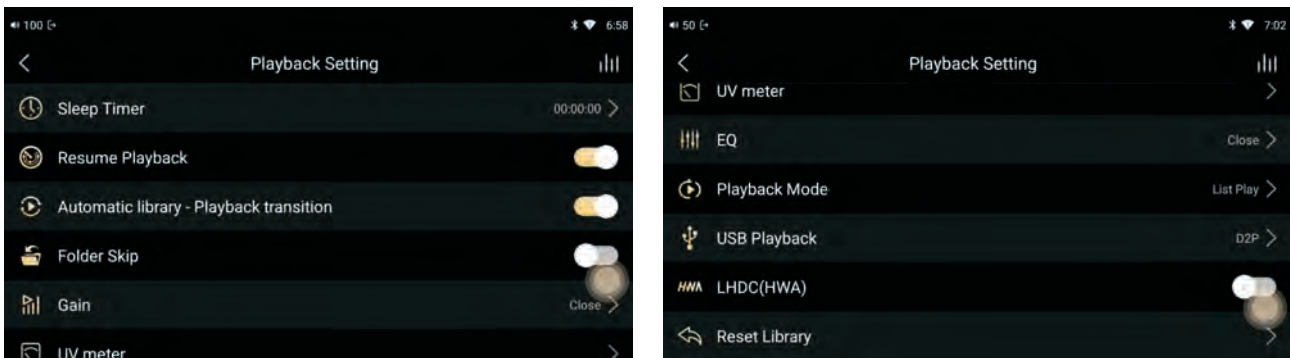

Use the back arrow at the top left of the screen for all future navigation.

These settings are to be configured to your personal preferences.

Sleep Timer:

Can be set if required. Otherwise simply leave at factory setting of 00.00.00

Resume playback:

Set to either on/off.

Automatic library - Playback transition:

Select on or off. This option automatically opens the Playback page when a song is selected in the list.

Folder Skip:

Select on or off.

Gain:

ReplayGain function, set to either on/off.

UV meter:

Set whether the digital UV meter should show up on now playing screen.

There are options for 3 different colors of the display.

EQ:

Select on or off. Here you can enter your own equaliser settings. Press Close. Next choose On and set to your preferences.

Playback mode:

Choose from List Play / Shuffle / Repeat All / Repeat Track.

USB Playback (DSD)

Select D2P, DoP (uses original material without conversion) or Native. Default is D2P. Affects only USB output to external DAC.

LHDC:

Select on or off. LHDC is a bluetooth transmitter, when selecting on, LHDC encoding is turned on. If headphones or earphone support LHDC, the LHDC encoding is used to transmit data. Due to version used, some headsets might not correctly display S2 as LHDC compatible.

Reset library:

Take care here as resetting **will delete** all playlists, favourites, recently played and file information.

Once all system settings and playback settings have been entered, press the back arrow once more to take you to the actual operation screen.

Scan Songs:

If you are using a USB memory stick or hard drive in either USB-1 or USB-2 or if you have used a wi-fi file transfer, you must scan songs into the system. Initially all songs will be saved to Local Songs. Tap Scan Songs followed by Scan Now and you will receive information about how many songs have been scanned.

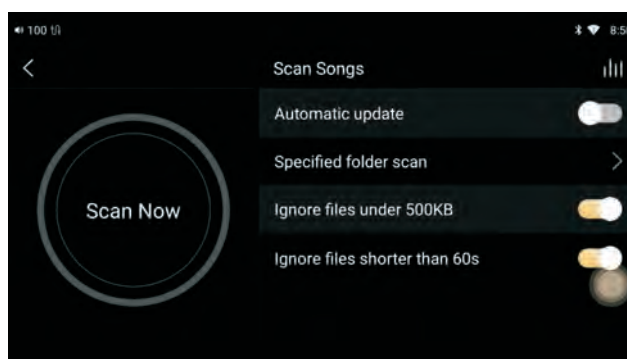

Local Songs:

Choose Local Songs to begin to listen to your music. Remember you must have chosen local songs from your Input Switching Options.

This gives you options of how to listen to the songs by Songs / Artist / Album / Genres and Playlists. Choosing one of those options you will see all songs/artist/album listed alphabetically. You can add further information as follows...

Songs: Pressing the 4 vertical lines symbol at top right of screen after selecting a song, you will see details of the album showing the cover, album title and artist. Directly underneath the album cover you will see a heart - pressing this adds the particular song to your **Favourites**. You will also see the number the particular song appears on the album.

Pressing the information icon takes you to more available detailed information relating to the song.

Going back to the song itself and pressing the symbol to the right of the song gives you even further information and also allows you to position where the song might appear in your listing (Add To). You can also add it to a playlist. **Create a playlist** by name by touching the + at the top right of screen. You can add as many playlists as you wish.

If desired you can also delete the song and you have the options to remove from everywhere you may have added it (i.e. Favourites/Playlists).

Artists/Albums: You have the same options as Songs.

You will notice that if you choose to navigate to other areas to check on settings etc. the music will continue to play.

Playlist:

Choosing Playlist from the menu will take you to a screen that lists **Playlists** and **Favourites**.

Folder:

This contains information relating to internal and external storage. Internal is system information only - external relates to anything you may have transferred via your wi-fi file transfer. You can still play from this folder if you wish.

Network Services:

DLNA:

Note there are two features:

DMS (Digital Media Server) requires an external storage device connection (e.g., usb flash drive, portable hard disk), and then turn on the DLNA button.

Example: A third-party App (e.g. mConnect, bubbleUPnP) browses a file directory Shared by DMS on the S2. You can then browse this file directory Shared by the S2 on (for example) mConnect.

DMR (Digital Media Renderer) opens with DLNA, closes with DLNA.

Example: A third-party App (e.g. mConnect, bubbleUPnP) plays audio files via DMR on the S2. Use the S2 to play audio files on mConnect.

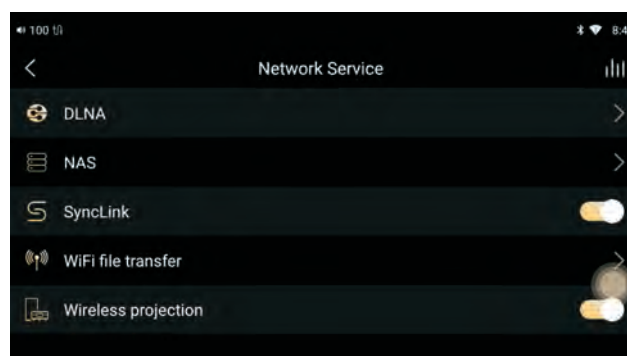

Turn DLNA On or Off

Add DLNA shared folder.
DLNA Shared Folder list.

NAS:

Search for NAS servers.

SyncLink:

Enable to control S2 Local file playback over Bluetooth, using Eddict player app on your smartphone or tablet.

Wifi file transfer:

Both your PC and S2 must be using the same network. Check that your wifi connection is still on (System Settings WLAN or Ethernet). Choose USB-DAC from the input selection options.

You will see an instruction on the file transfer screen to go to your browser on your PC and type in <http://10.0.0.129:8080> Please note the colon : in the link address.

This will take you to an area where you will be able to upload files from your PC to the S2.

Note: Prior to making this connection click on the settings icon on the top right hand side of the screen. It will provide you with a choice of storing the material permanently in the S2 internal storage. Touch internal storage and you will be taken to a large selection of options.

This can be changed each time you upload but it must be done prior to the upload.

Wireless projection:

Enable to completely control S2 over Wi-Fi, using Eddict player app on your smartphone or tablet. The display of S2 will be completely mirrored on your smartphone, giving you access to all functions and menus of S2.

Swipe Down menu

SRC:

Click to turn On / OFF SRC (Fixed output sampling rate). Long press to enter Fixed output sampling rate settings screen. In system settings

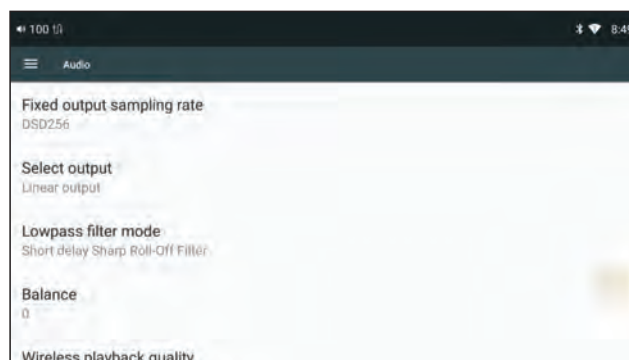
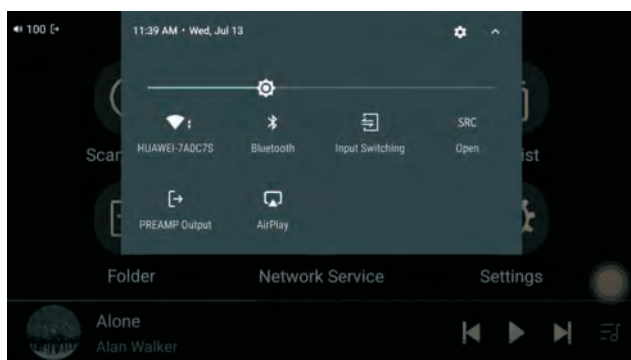

PreAmp Output // Line-Out.

Switch between Pre-amplifier or Line-Out output, this will affect ability to control volume directly on the S2.

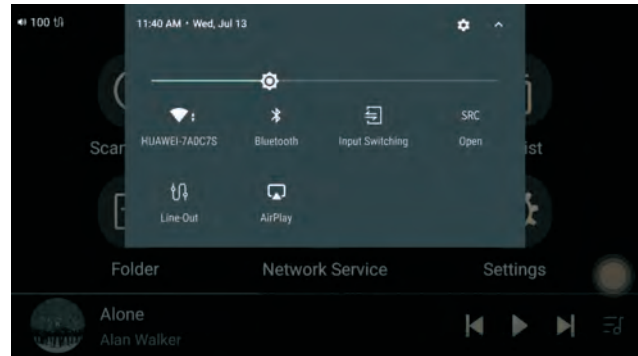
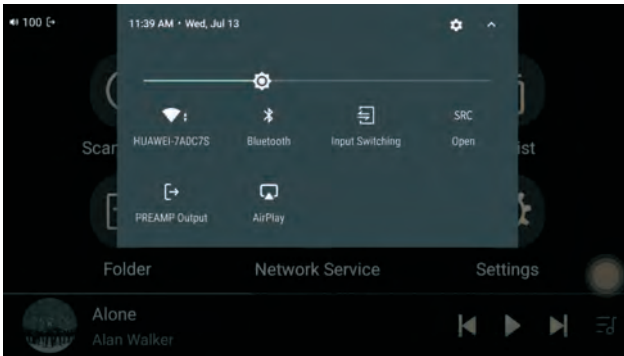

Input Switching:

Choose your input of choice, remembering that to listen to material on USB you choose Local Songs. Remember you need to scan the material from your USB for it to appear in the local songs library.

In order to use the USB-DAC option a **download is required for Windows. No download required for Mac.**

The file can be downloaded from the YBA website - www.ybahifi.com/downloads.html

After downloading and installing you will have the option via your sound settings to use the Eddict Audio Device to listen to music stored on your PC. Your PC's previous audio output device will be temporarily disabled and the S2 will become the default audio device. If you wish to disconnect your S2 and return to your soundcard navigate back to your sound settings and choose your PC output. You will need to choose USB-DAC from the input switching option.

When choosing Coaxial/Optical and USB-DAC the S2 is acting as a high quality DAC decoder.

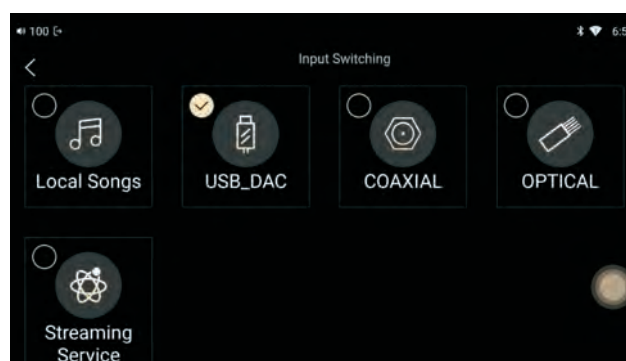

Genesis S2 Streaming Music Centre

Streaming Services:

Currently there are ten streaming options installed with more to follow in an upcoming firmware update.

It is necessary to enter your account details in each of these and then login. These details will only have to be entered once.

If signing up to one of these services for the first time, we have found it is easier to sign up via your PC or mobile device and then enter the login details into the S2.

Provided your wifi connection is a good one, you simply select the option of your choice to listen to your preferred music.

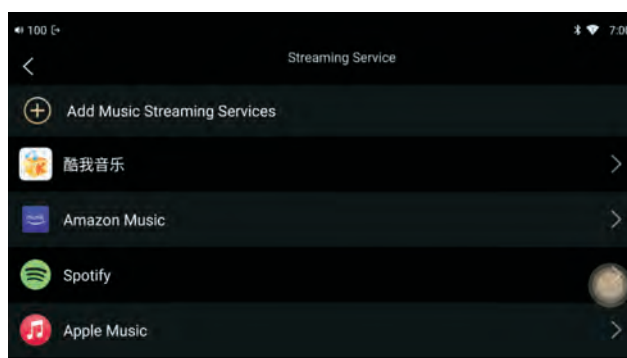

Copying files from USB drives to internal SSD:

Open Folder browsing and navigate to the files on USB Drive. Click on the multi-selection button in top right corner and choose which files you wish to copy. Then click on Copy and pick the SSD location. It's recommended to play files from the internal SSD for optimal performance.

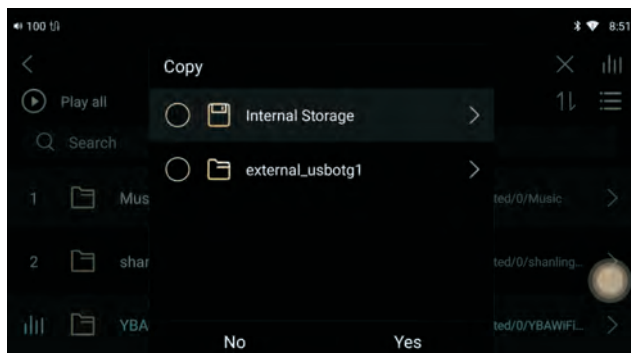
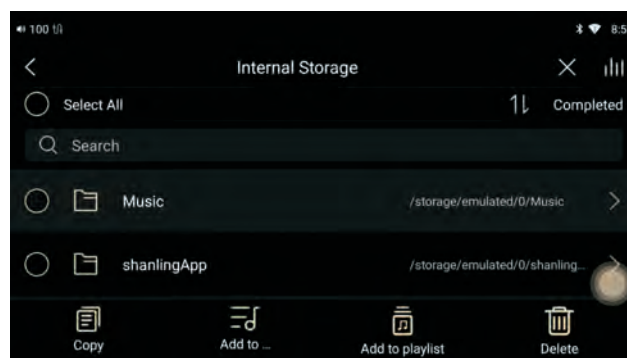
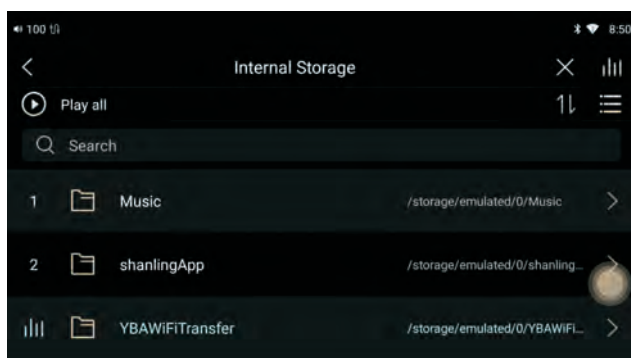

S2 SPECIFICATIONS

FILE FORMAT

| | |
|--------------------------|--------------------------------------|
| Supported formats | AIFF, WAV(LPCM), FLAC, MP3, WMA, AAC |
| Supported sampling rates | DSD512 32 - 768KHz |
| Supported resolution | 16bit, 24bit, 32bit |

NETWORK

| | |
|-----------------|--------------------------------------|
| Ethernet | 10/100 Base-T (RJ45) |
| WiFi | IEEE 802.11b/g/n |
| WPS | Compatible |
| DLNA | 1.0/1.5 compatible |
| UPnP | DMP/DMR |
| Network Service | Selected streaming services included |
| AirPlay | Yes |

AUDIO

| | |
|----------------|--|
| Digital inputs | Coaxial, Optical, USB (DAC), USB (host), Bluetooth 4.2 with LDAC |
| Audio outputs | Gold plated RCA, Balanced XLR |

LINE OUT

| | |
|-----------------------|---------|
| RCA output level | 2.25V |
| Balanced output level | 4.5V |
| SNR | 107 dB |
| THD+N | 0.0008% |

| | |
|--------------------|---|
| D/A Converter | AKM AK4497SEQ x 2 (32 bits / 768kHz capable) |
| Power supply | Linear power supply with high performance transformer |
| Dimensions (wxdxh) | 430 mm x 388 mm x 115 mm |
| Finish | Black |
| Weight | 9.1 kg |

YBA



www.ybahifi.com

info@ybahifi.com